

13 12 11 10 9 8 7 6 5 4 3 2 1

J  
I  
H  
G  
F  
E  
D  
C  
B  
A

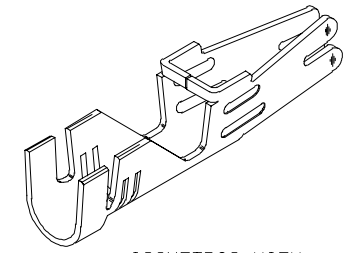

ISOMETRIC VIEW  
(SCALE 4:1)

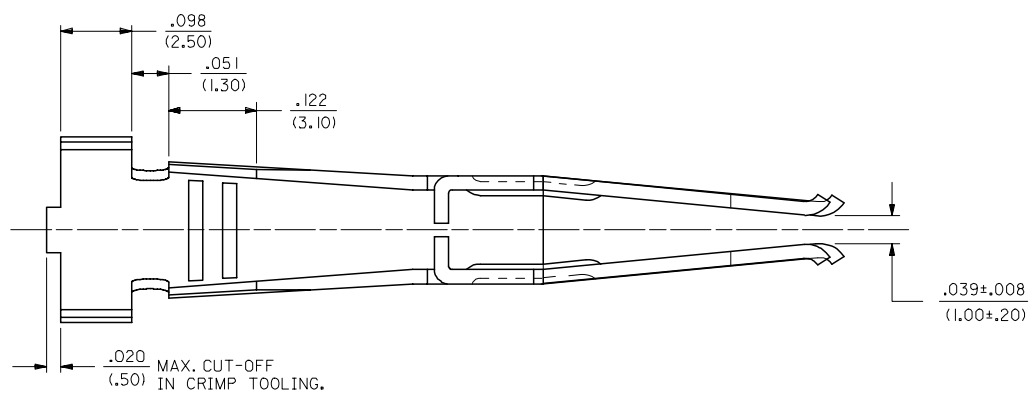
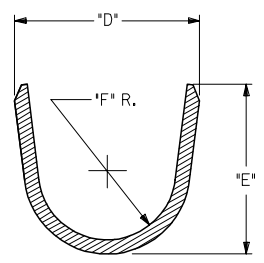
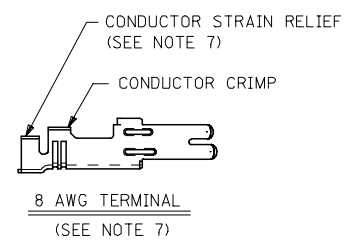
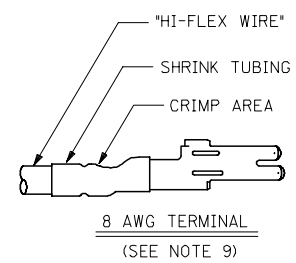
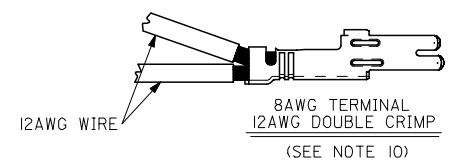
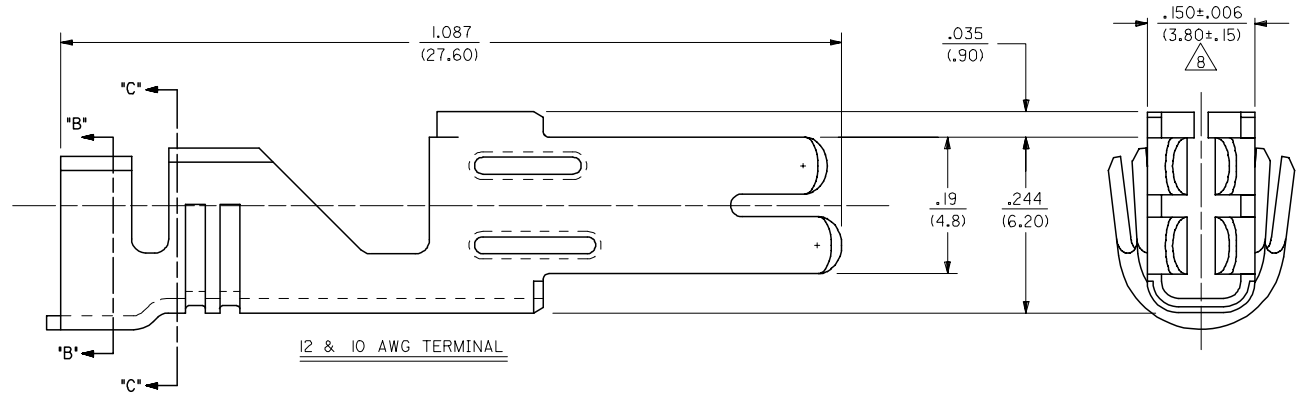

SECTION B-B

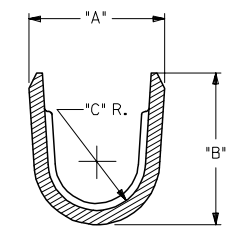

SECTION C-C  
(BACKGROUND OMITTED)

REDRAWN IN ME10 EC NO: UCP2005-2769 DRAWN: JCOMERC 2005/06/17 CHKD: 2005/06/17 APPR: JCOMERC 2005/06/17 H1	QUALITY SYMBOLS ▽=0 ▽=0	GENERAL TOLERANCES (UNLESS SPECIFIED) <table border="1"> <thead> <tr> <th></th> <th>mm</th> <th>INCH</th> </tr> </thead> <tbody> <tr> <td>4 PLACES</td> <td>± .010</td> <td>± .0004</td> </tr> <tr> <td>3 PLACES</td> <td>± .015</td> <td>± .0006</td> </tr> <tr> <td>2 PLACES</td> <td>± 0.25</td> <td>± .010</td> </tr> <tr> <td>1 PLACE</td> <td>± 0.40</td> <td>± .016</td> </tr> <tr> <td colspan="3">ANGULAR ±1/2°</td> </tr> </tbody> </table>		mm	INCH	4 PLACES	± .010	± .0004	3 PLACES	± .015	± .0006	2 PLACES	± 0.25	± .010	1 PLACE	± 0.40	± .016	ANGULAR ±1/2°			DIMENSION STYLE IN/MM	SCALE 8:1	DESIGN UNITS METRIC	THIRD ANGLE PROJECTION
		mm	INCH																					
	4 PLACES	± .010	± .0004																					
	3 PLACES	± .015	± .0006																					
2 PLACES	± 0.25	± .010																						
1 PLACE	± 0.40	± .016																						
ANGULAR ±1/2°																								
DRAWN BY RJP	DATE 1/6/92	CHECKED BY RJP	DATE 1/6/92	TITLE FEMALE CRIMP TERMINAL, 12, 10 & 8AWG MINIFIT SR.																				
APPROVED BY RAS	DATE 1/6/92	MATERIAL NO. SEE CHART			DOCUMENT NO. SD-42815-*	SHEET NO. 1 OF 2																		
DRAFT WHERE APPLICABLE MUST REMAIN WITHIN DIMENSIONS							THIS DRAWING CONTAINS INFORMATION THAT IS PROPRIETARY TO MOLEX INCORPORATED AND SHOULD NOT BE USED WITHOUT WRITTEN PERMISSION																	

12 11 10 9 8 7 6 5 4 3 2 1

ITEM NUMBER	WIRE RANGE	DIM. A	DIM. B	DIM. C	DIM. D	DIM. E	DIM. F	MAX. INSULATION DIAMETER	PLATING
42815-0011	12 & 10 AWG	.213±.024 (5.40±.60)	.240±.016 (6.10±.40)	.067 R. (1.70)	.232±.024 (5.90±.60)	.260±.016 (6.60±.40)	.087 R. (2.20)	.209 DIA. (5.30)	OVERALL TIN
42815-0031	8 AWG	.229±.024 (5.83±.60)	.292±.016 (7.42±.40)	.067 R. (1.70)	.236±.024 (6.00±.60)	.216±.016 (5.50±.40)	.087 R. (2.20)	.260 DIA. (6.60)	
42815-0012	12 & 10 AWG	.213±.024 (5.40±.60)	.240±.016 (6.10±.40)	.067 R. (1.70)	.232±.024 (5.90±.60)	.260±.016 (6.60±.40)	.087 R. (2.20)	.209 DIA. (5.30)	SELECT GOLD
42815-0032	8 AWG	.229±.024 (5.83±.60)	.292±.016 (7.42±.40)	.067 R. (1.70)	.236±.024 (6.00±.60)	.216±.016 (5.50±.40)	.087 R. (2.20)	.260 DIA. (6.60)	

**NOTES:**

- 1) MATERIAL: COPPER ALLOY 151, .020/(.50) THICK.
- 2) PLATING:
  - 1 = .000100/(.00254) MIN. \*TIN OVER  
.000050/(.00127) MIN. NICKEL.
  - 2 = .000030/(.00076) MIN. SELECT GOLD IN CONTACT AREA.  
.000100/(.00254) MIN. SELECT \*TIN ON SOLDER TAILS  
OVER .000050/(.00127) MIN. NICKEL.
- \* THE PRIMARY SHIPPING CARTON WILL BE LABELED  
COMPLIANT TO RoHS DIRECTIVE 2002/95/EC  
AND ELV ANNEX II OF DIRECTIVE 2000/53/EC.  
CARTONS WITHOUT THIS LABEL MAY CONTAIN  
PRODUCT WITH TIN-LEAD.
- 3) PRODUCT SPEC.: PS-42815-001
- 4) PART IS DESIGNED IN METRIC.
- 5) TERMINALS FOR USE WITH STRANDED WIRE ONLY.
- 6) ITEM NUMBERS PRECEDED BY AN 'X' IN THE CHART ARE NOT AVAILABLE.
- 7) THE 8 AWG TERMINAL HAS NO INSULATION CRIMP. THE SECONDARY CRIMP SECTION  
ACTS AS A STRAIN RELIEF ON THE BARE CONDUCTOR ONLY. SEE MOLEX CRIMP  
SPECIFICATION FOR DETAILS.
- 8) AFTER CRIMPING, THIS DIMENSION IS .140/(3.55) MINIMUM.
- 9) WHEN USING THE 8 AWG TERMINAL WITH "SUPERFLEX WIRE",  
MOLEX STRONGLY RECOMMENDS THAT THE APPROPRIATELY  
RATED HEAT SHRINK INSULATION BE APPLIED OVER THE WIRE  
INSULATION AND CRIMP AREA, AS SHOWN, TO MINIMIZE WIRE  
INSULATION CREEPAGE OUTSIDE OF HOUSING.
- 10) THE 8AWG TERMINAL WILL ALSO ACCOMODATE 2 I2AWG WIRES  
SEE CRIMP SPEC FOR DETAILS.
- 11) CRIMP SPECS.:  
638210000 FOR 10AWG & 12AWG  
638300000 FOR 8AWG, 8AWG HI-FLEX & DOUBLE 12AWG

**LEGEND:**

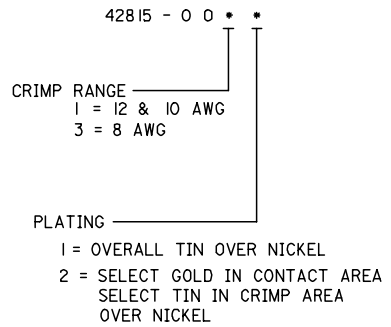

SEE SHEET 1 EC NO: UCP2005-2769 DRAWN: JCOMERC CHKD: JCOMERC APPR: JCOMERC H1	2005/06/17 2005/06/17 2005/06/17	DESCRIPTION QUALITY SYMBOLS ▽=0 ▽=0	GENERAL TOLERANCES (UNLESS SPECIFIED)		DIMENSION STYLE IN/MM		SCALE 8:1	DESIGN UNITS METRIC	THIRD ANGLE PROJECTION		
			4 PLACES ± --- ± ---	mm	INCH	DRAWN BY RJF	DATE 1/6/92	TITLE FEMALE CRIMP TERMINAL 10-12 AWG & 8 AWG MINIFIT SR. SERIES			
			3 PLACES ± --- ± .010			CHECKED BY RJF	DATE 1/6/92	MOLEX MOLEX INCORPORATED			
			2 PLACES ± 0.25 ± .016			APPROVED BY RAS	DATE 1/6/92	DOCUMENT NO. SD-42815-*			
1 PLACE ± 0.40 ± ---		ANGULAR ±1/2°		MATERIAL NO.		DOCUMENT NO.		SHEET NO. 2 OF 2			
DRAFT WHERE APPLICABLE MUST REMAIN WITHIN DIMENSIONS			SEE CHART		THIS DRAWING CONTAINS INFORMATION THAT IS PROPRIETARY TO MOLEX INCORPORATED AND SHOULD NOT BE USED WITHOUT WRITTEN PERMISSION						